



ACTIVITY BOOK

THE HIGHLANDERS



Check out the mazes, word searches and crossword puzzles! All are themes for this years 2016 FRC Stronghold Challenge!



Featuring Rocky and David, our team illustrated characters! Check throughout the book to see what they are up to now!

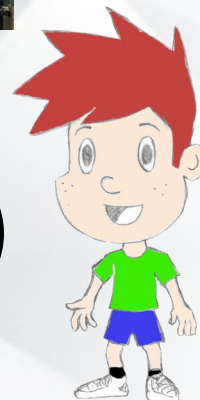

#4499

Get your Robot to the spaceship!

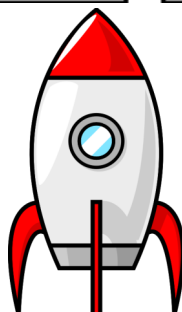
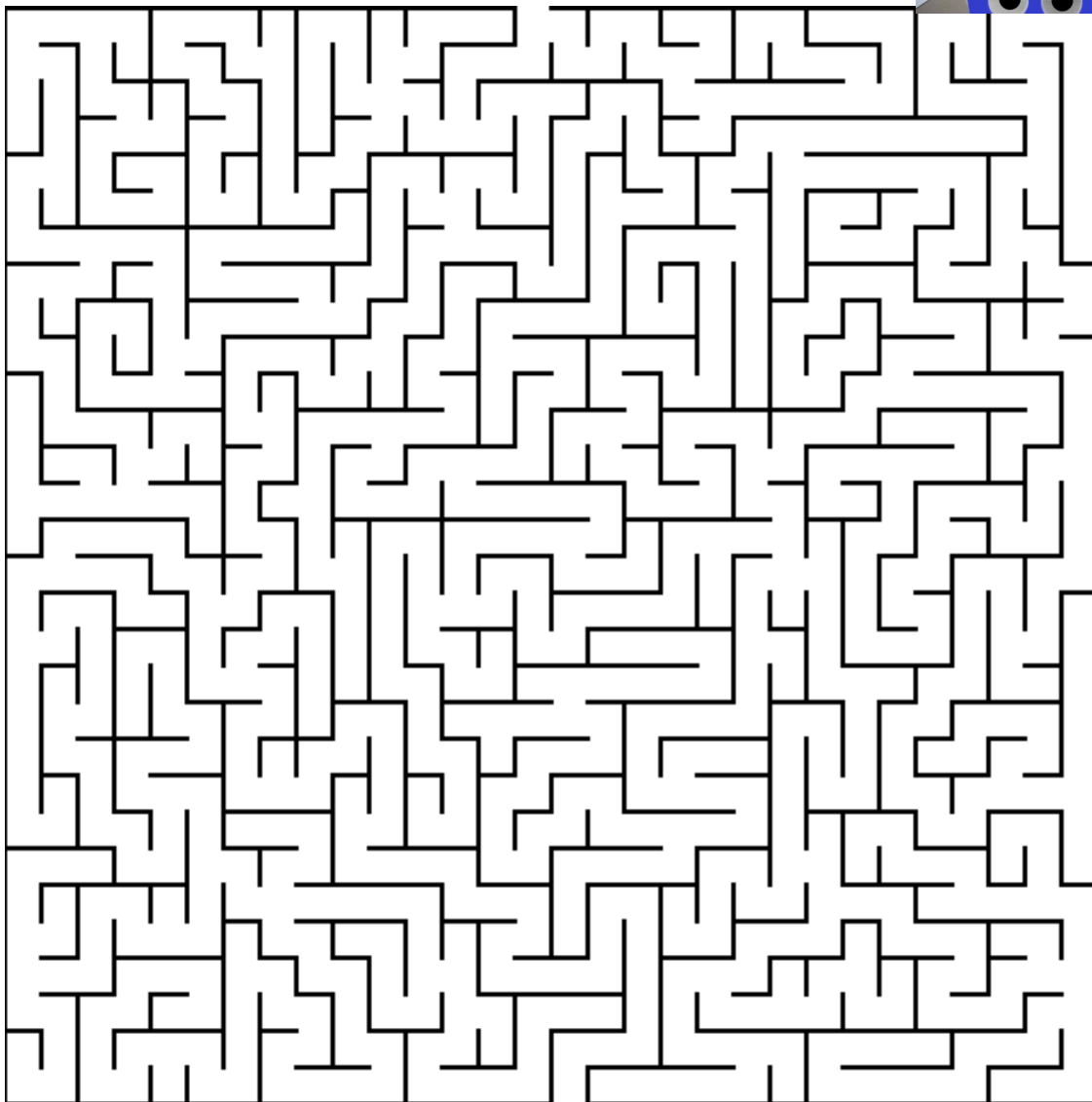
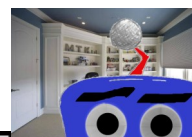
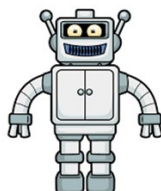

DOT-TO-DOT

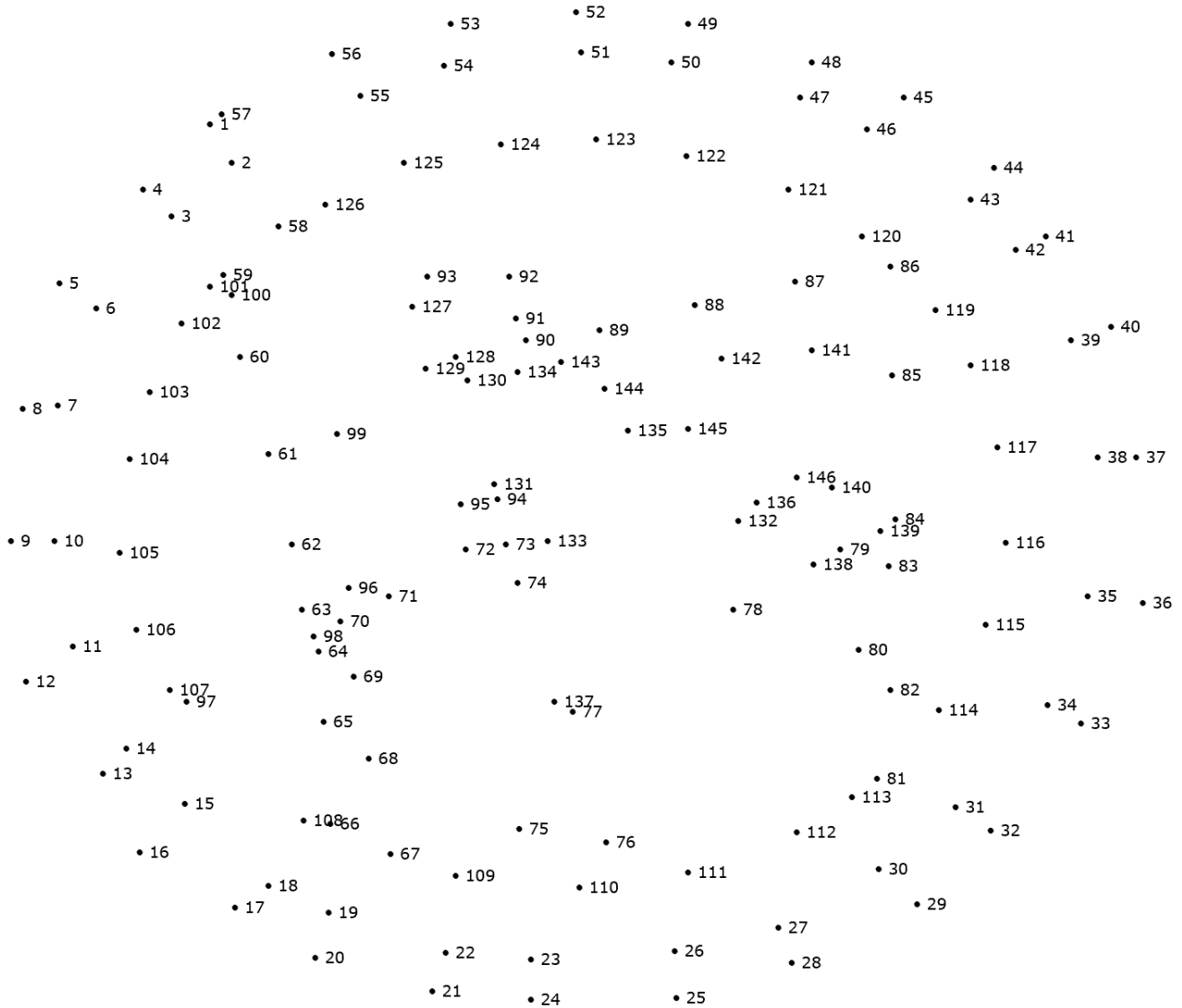

Find the Hidden Treasure

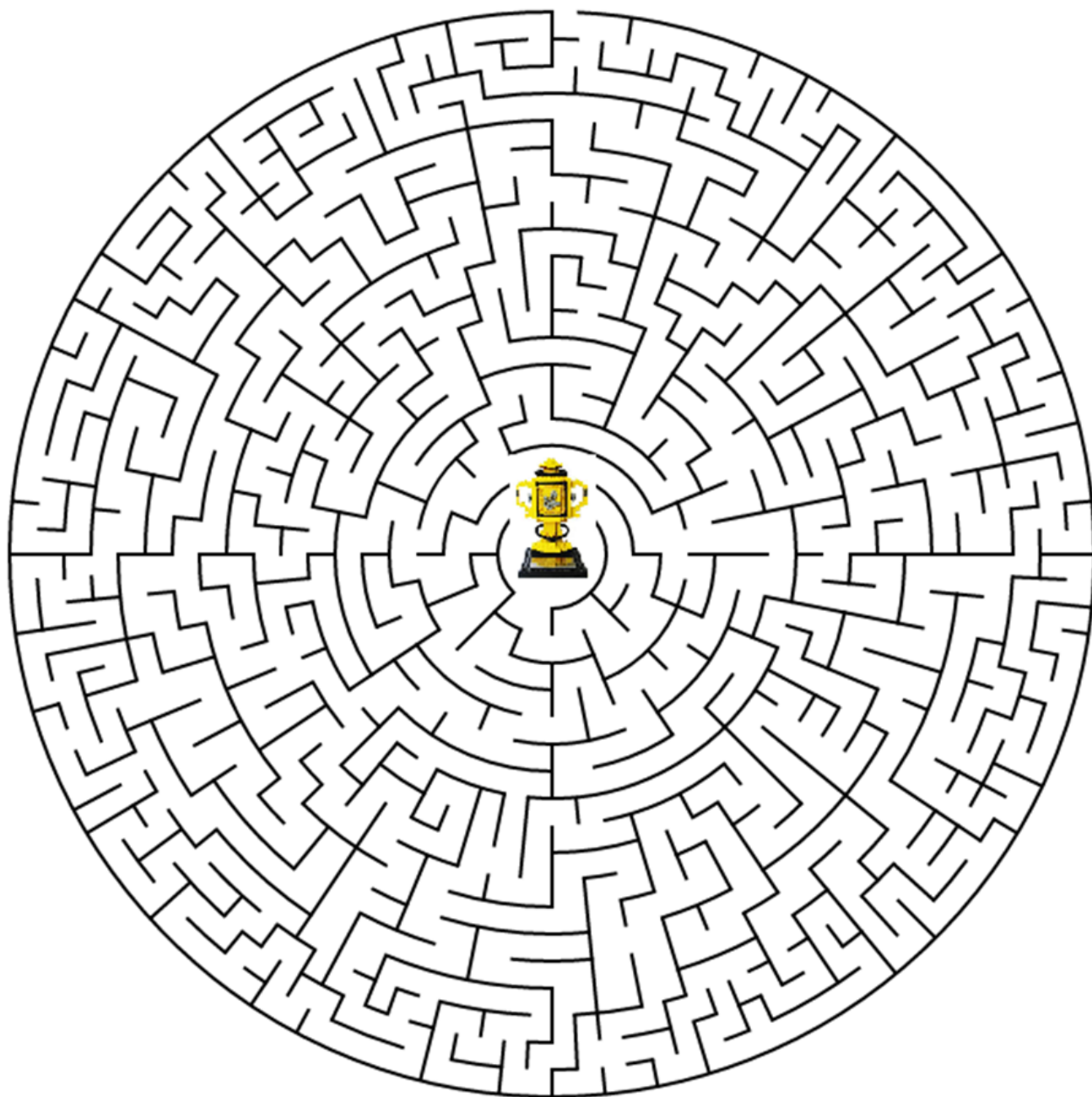

HOW TO DRAW ROBOTS?

3 STEPS TO DRAW A FUN ROBOT

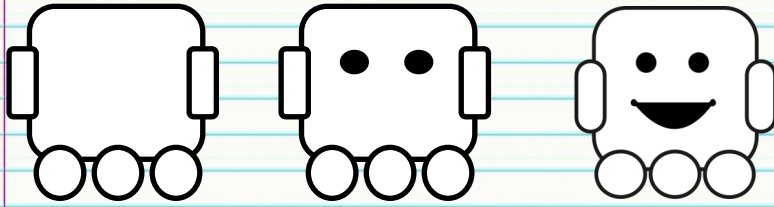

ANOTHER ROBOT....

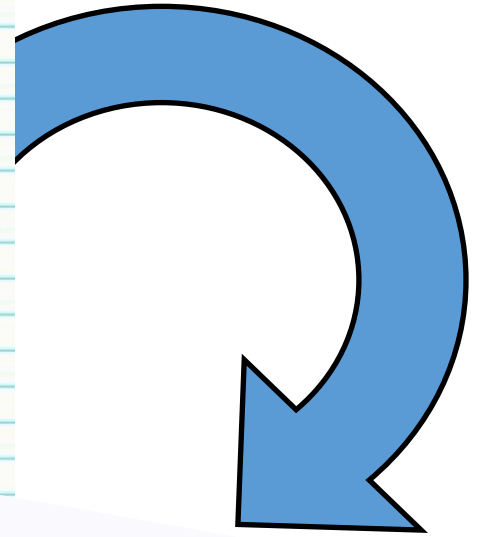
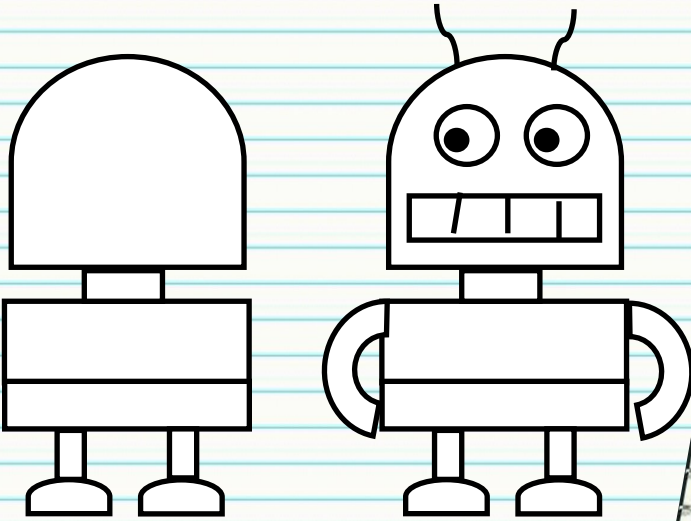

CAN YOU MAKE THIS ROBOT
BETTER OR CAN YOU MAKE ONE
ON YOUR OWN?

DRAW
ROBOTS!

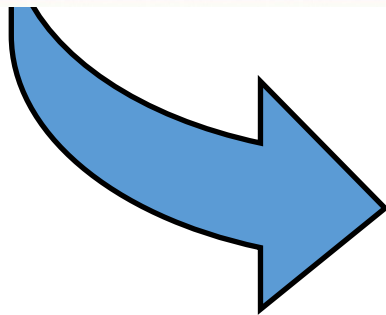

Robot Parts Search

T Y V H I A F R T H S F C A V L X V D P H U L N V
I Y W F M V I G X S W T W G X R I C H I O D M J M
J C G F N C R S J P T L H J A V I V W S K B B D P
Q P J Z T O P W G K U U R G W P Z D V T T Q S F N
M O T O R X B I K Q E J D B I C Z E V O H W N B Y
M B F V U E A R V Q U N S A K L V N P N E Z D Z M
J Y K R Y X N E A K M U K T A L U M I N U M Y O K
L D R G K H Q S G C G X E T S U T E D F B R P E F
D Z L C H X W F L N W W A E Z L S Z O Y C E U B Z
Q T C T Z Z W L D M I Q N R P Q M U V G X L U G O
O I R O B O R O G D S B I Y G G I V G Q Z L B Z C
W K I S W O E S V I D I U S D L Z J N S M T M I V
Y V R G P T F I B E R L A T E M U I T W K Y O J G
G D O L Z R X C G S Z W V L B U M P E R S U T M K
O K X R J P Z S E P K H S C I T A M U E N P F D A
E V T C X J J K R J X E X I R O C R A F W U Y J D
A O Q Q U N J M X A Y E Y W X P G T W O O T J I F
E X P P Q W O C D U W L H Q K G P C F P Q I F C P
B O L Z W Z B Y N A X S C Z N T S O D C E D C P Y
R T B P G G O G I W E H I H H I R X U L L U A L U
O Y E R G E V W H J E R E Q A Z E F X W R S M X X
U D L O P X Y J R N K A T G N I R A E B H F E Z W
T I T I E O I P M O K Q Z M B X N P Z M M T R X E
E B S G E Q B F Q E G S R T J S Y L Y P S G A D H
R I R W D M F K M O W W S D S Q E V G N S M H J U

MOTOR

WHEELS

WIRES

PNEUMATICS

METAL

BATTERY

ALUMINUM

PISTON

BELTS

CHAIN

TREAD

TUBING

BUMPERS

CARBON FIBER

BEARING

AXLE

LIGHTS

ROBORIO

ROUTER

CAMERA

HELP DRAW ROCKY

You can draw Rocky too! Draw what is in each box the best you can and then you will see how great of an artist you are! Have fun and get creative.

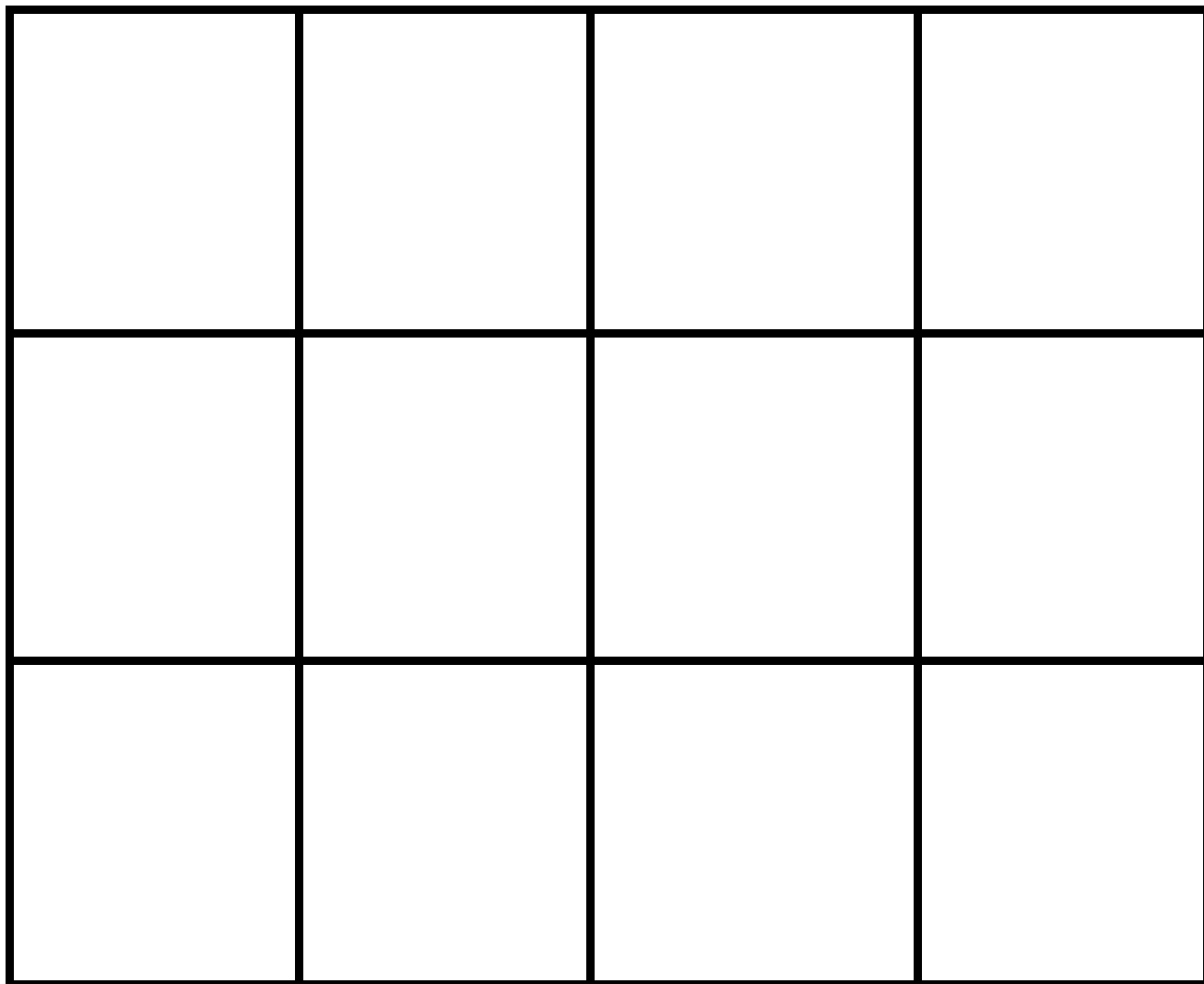
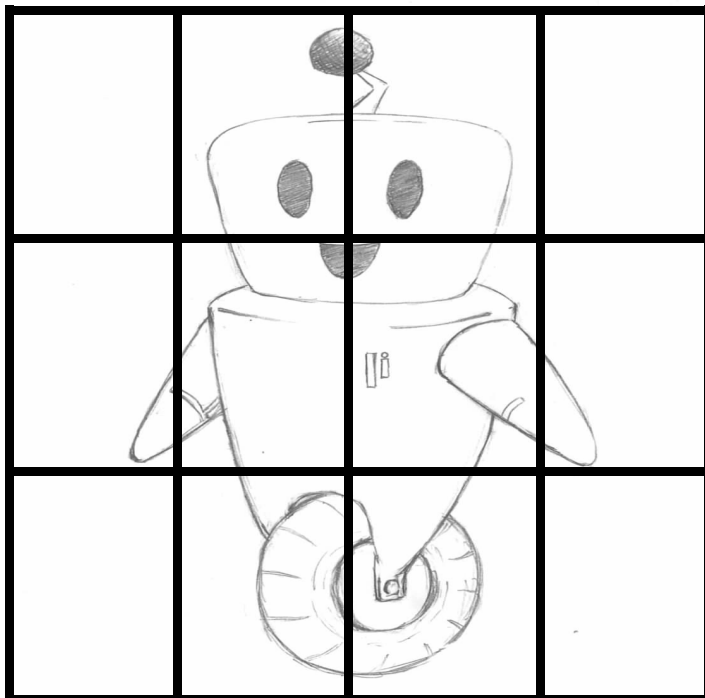



Get the Martian into the Tower.

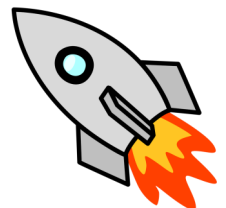
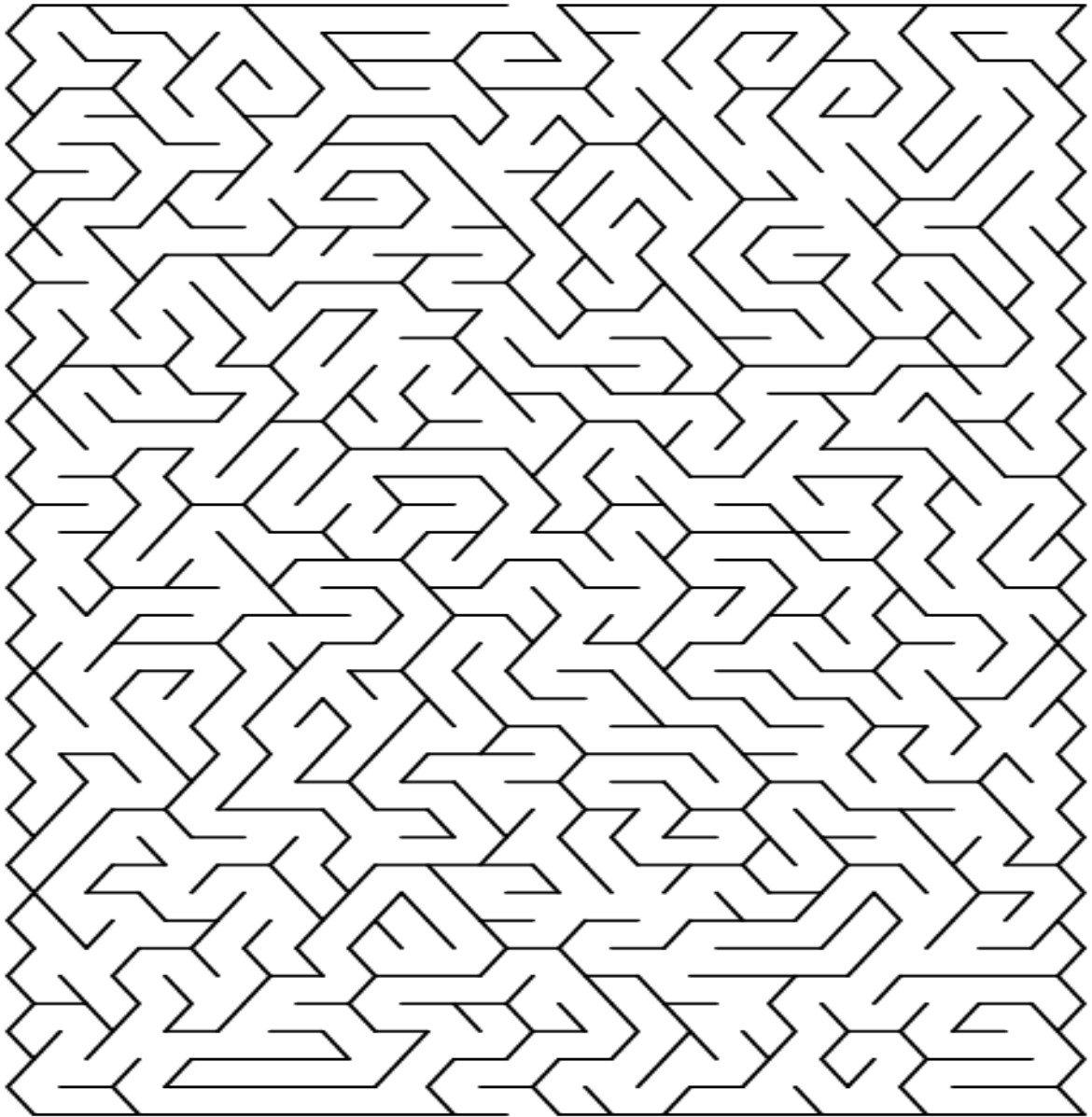

CAN YOU FIND THE CLUES TO FILL OUT THE PUZZLE?

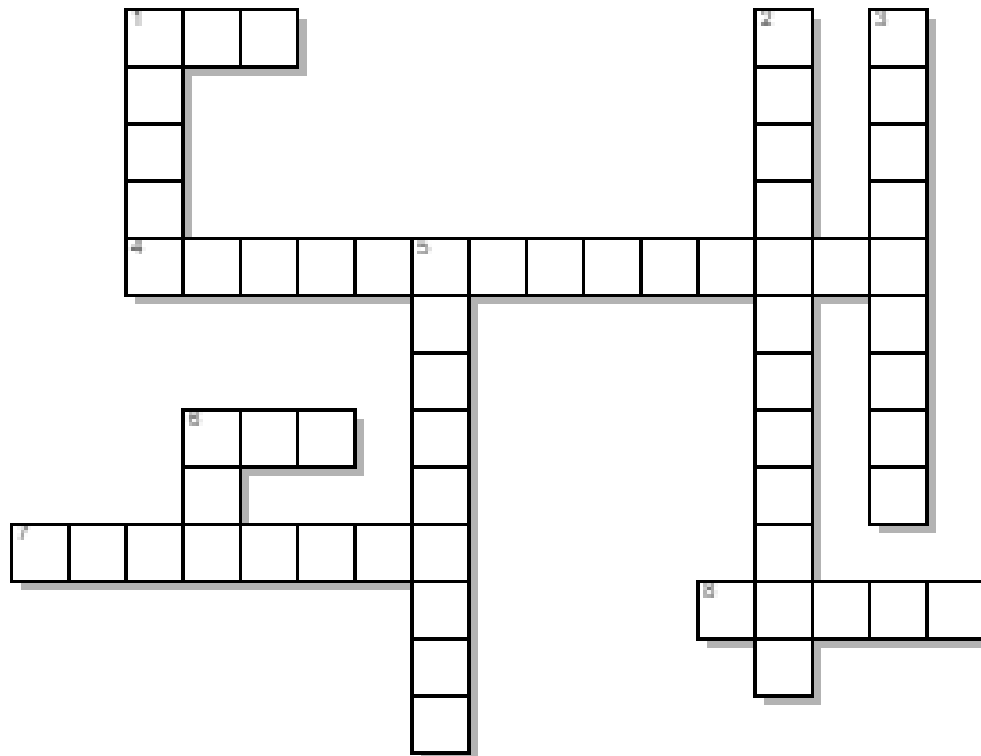

ACROSS

- 1 First Tech Challenge
- 4 Team#4499 Name
- 6 First Lego League
- 7 Professionalism
- 8 The Highlanders Story
book Robot name

DOWN

- 1 For Inspiration of
Science and Technology
- 2 Fun Competition
- 3 2019 FRC Season Name
- 5 The Highlanders 2019
Robot Name
- 6 First Robotics
Competition

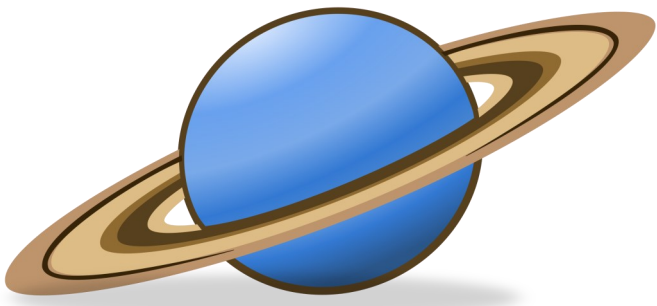

Receive your medal!

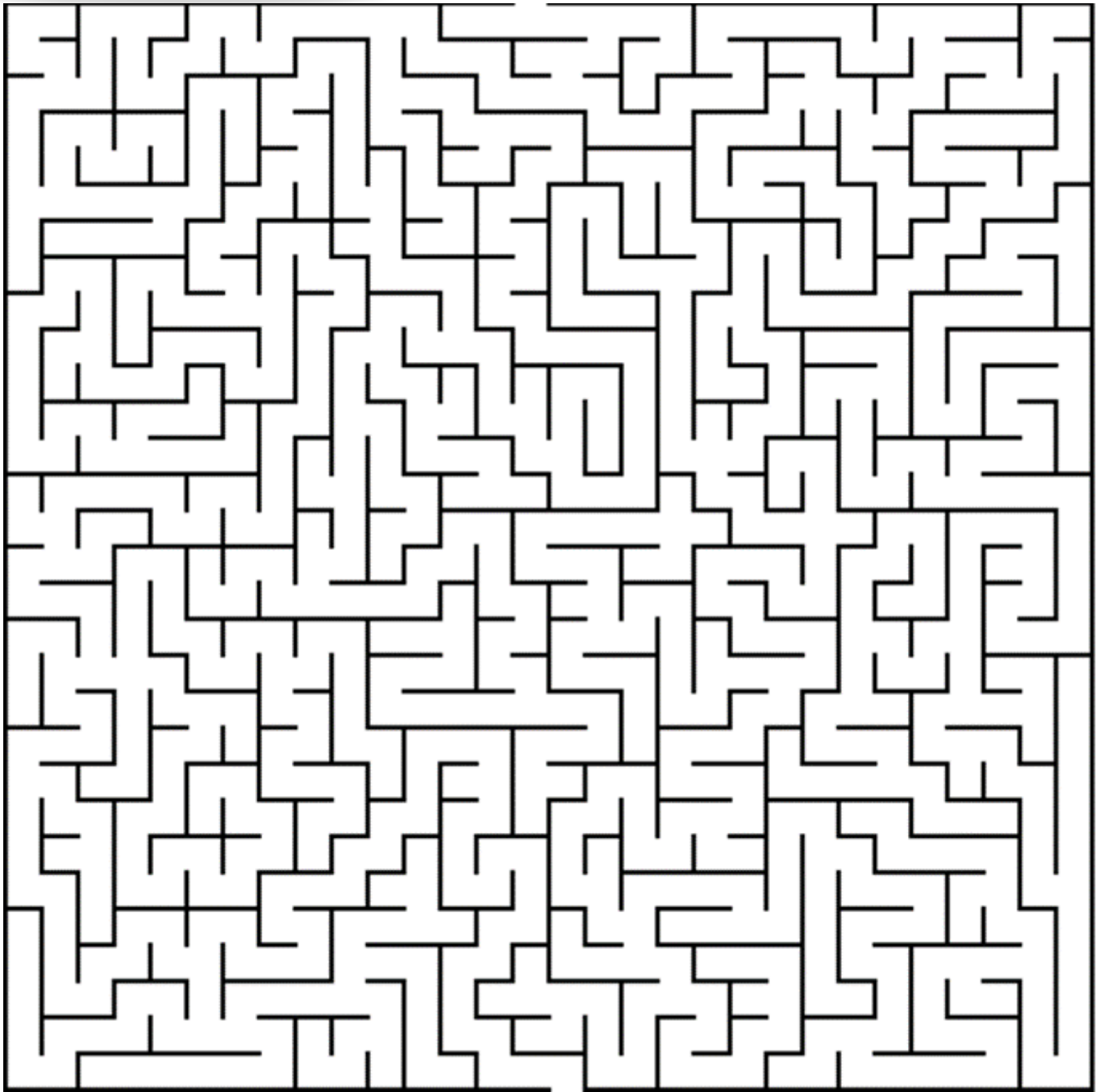

MATCH THE LEFT COLUMN WITH THE
CORRECT RIGHT COLUMNS

4499

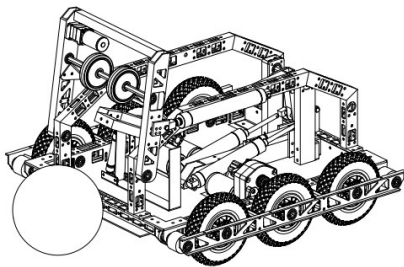
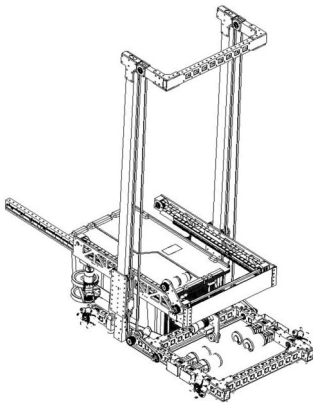
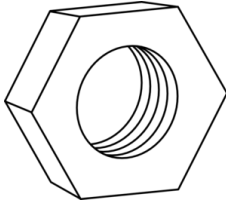

FIRST STRONGHOLD

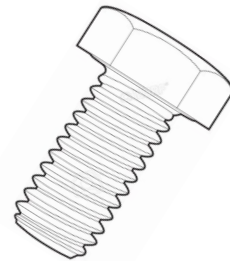

RECYCLE
rush

THANK YOU TO OUR SPONSORS, TEAM MEMBERS, FAMILIES AND FRIENDS

SPONSORS



The Highlanders
FRC Team 4499



4th of July Parade!



4499